



## 2/2-way Angle-Seat Control Valve with stainless steel design for media up to +180°C, DN 13-50

- Excellent control characteristic and high flow rates
- High cycle life
- Clean design for optimal use in hygienic environment
- Quality certifications available

Type 2300 can be combined with...



**Type 8692/8693**  
Positioner / Process Controller TopControl



**Type 8694**  
Positioner TopControl Basic



**Type 8696**  
Positioner TopControl Basic



**Type 8137**  
Radar level transmitter



**Type 8222**  
Conductivity transmitter

In line with Bürkert's philosophy for modular valves and sensors the construction of the 2300 angle-seat valve fulfils tough criteria for process environments. Unrivalled cycle life and sealing integrity is guaranteed by the proven self adjusting packing gland.

The parabolic trim results in a flow characteristic approximately 35% larger than conventional control valves. It is available in either stainless steel on stainless steel or with a durable PTFE seal for tight shut-off.

The design enables the easy integration of automation modules whether they are digital electro-pneumatic positioner or process controller.

The fully integrated system has a compact and smooth design, integrated pneumatic lines, IP65/67/NEMA4X protection class and superior chemical resistance.

This system has been engineered for reliable accurate control in applications where high flow rate is an advantage.

Technical data	
<b>Orifice</b>	DN 13 to 50
<b>Port connections</b>	Threaded port acc. to Welded acc. to  Clamp acc. to
<b>Body material</b>	Stainless steel 316L
<b>Actuator material</b>	Actuator Cover
<b>Plug sealing</b>	PTFE/St.st. (PTFE/stainless steel) and St.st./St.st. (stainless steel/stainless steel)
<b>Seat leakage IEC 534-4/EN 1349</b>	Shut-off class IV for St.st./St.st. Shut-off class VI for PTFE/St.st.
<b>Media</b>	Water, alcohol, oils, fuels, hydraulic fluids, salt solution, alkali solutions, organic solvents, steam
<b>Viscosity</b>	max. 600 mm <sup>2</sup> /s
<b>Packing gland</b>	PTFE V-rings with spring compensation
<b>Medium temperature</b>	-10 to +180 °C (max. +130°C for PTFE/St.st. sealing recommended)
<b>Ambient temperature</b>	0 to +60 °C
<b>Control medium</b>	Compressed air
<b>Pilot pressure</b>	5.5 to 7 bar
<b>Pilot air ports</b>	Push-in connector for external ø 6 mm or 1/4" tube
<b>Installation</b>	As required, preferably with actuator in upright position

### Content

Valve specifications	System spec. Continuous ELEMENT	Request for quotation
<b>Type 2300</b>	<b>Type 8802-YG</b>	<b>Type 8802-YG</b>
Technical data & ordering info. p. 1-7	Ordering info. & technical data p. 8-15	p. 16

## Technical data Type 2300, continued

### Kv values water/pressure

Orifice [mm]	Actuator size [mm]	Kv value water (m <sup>3</sup> /h)	Minimum pilot pressure [bar]	Operating pressure up to +180°	
				SFA [bar]	SFB [bar]
13	50	5.0	5.5	16	16
20	70	9.5	5.5	16	16
25	70	15.45	5.5	16	16
32	70	22.0	5.5	8.5	16
40	90	31.9	5.5	16	16
50	90	47.0	5.5	10	16

**Flow rate:** Kv value water [m<sup>3</sup>/h]; Measured at +20 °C, 1 bar pressure at valve inlet and free outlet.  
**Pressure valves [bar]:** Overpressure to the atmospheric pressure

### Flow characteristic

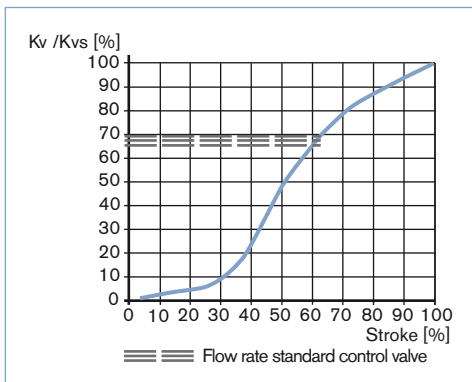

#### Remarks on the flow characteristic

Modified equi-percentile flow characteristic, engineered for a quick response during peak flow demand (an advantage for many processes like heating/cooling with heat exchangers) and fine control at lower flow.

### Kvs values [m<sup>3</sup>/h]

Port size and orifice [mm]	Stroke [%]											
	2.5	5	10	20	30	40	50	60	70	80	90	100
13/15	0.12	0.14	0.17	0.4	2.2	3.5	4.2	4.5	4.7	4.9	5.0	5.0
20	0.18	0.19	0.21	0.32	0.87	3.64	5.7	6.8	7.9	8.6	9.1	9.5
25	0.18	0.19	0.23	0.5	1.33	4.84	7.94	9.85	11.65	13.36	14.5	15.45
32	0.4	0.4	0.5	0.8	1.4	4.0	9.4	13.0	15.8	18.1	20.1	22.0
40	0.5	0.6	0.7	1.3	3.3	10.6	16.3	20.8	24.2	26.3	29.8	31.9
50	0.7	0.9	1.1	1.6	5.2	16.0	22.5	27.7	32.8	37.8	42.5	47.0

## Ordering chart Type 2300, flow direction below the seat (for gases and liquids)

## G threaded port

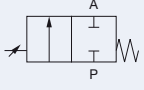
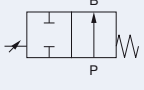
Control function	Orifice [mm]	Actuator size Ø [mm]	Port connection thread	Min. pilot pressure [bar]	Operating pressure up to +180°C [bar]	Item no. plug sealing PTFE/St. st.	Item no. plug sealing St. st./St. st.
<b>A</b> 2/2-way valve, NC 	13	50	G 1/2	5.5	16	203 318	206 222
	20	70	G 3/4	5.5	16	203 494	206 225
	25	70	G 1	5.5	16	203 496	206 227
	32	70	G 1 1/4	5.5	8.5	203 497	206 228
	40	90	G 1 1/2	5.5	16	203 498	206 229
	50	90	G 2	5.5	10	203 500	206 230
<b>B</b> 2/2-way valve, NO 	13	50	G 1/2	5.5	16	203 501	
	20	50	G 3/4	5.5	16	203 503	
	25	50	G 1	5.5	16	203 506	
	32	70	G 1 1/4	5.5	16	203 508	
	40	90	G 1 1/2	5.5	16	203 509	
	50	90	G 2	5.5	16	203 510	

## NPT threaded port

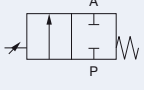
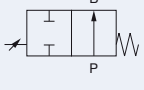
Control function	Orifice [mm]	Actuator size Ø [mm]	Port connection thread	Min. pilot pressure [bar]	Operating pressure up to +180°C [bar]	Item no. plug sealing PTFE/St. st.	Item no. plug sealing St. st./St. st.
<b>A</b> 2/2-way valve, NC 	13	50	NPT 1/2	5.5	16	203 529	206 231
	20	70	NPT 3/4	5.5	16	203 532	206 234
	25	70	NPT 1/2	5.5	16	203 534	206 236
	32	70	NPT 1 1/4	5.5	8.5	203 535	206 237
	40	90	NPT 1 1/2	5.5	16	203 536	206 238
	50	90	NPT 2	5.5	10	203 537	206 239
<b>B</b> 2/2-way valve, NO 	13	50	NPT 1/2	5.5	16	203 538	
	20	50	NPT 3/4	5.5	16	203 540	
	25	50	NPT 1/2	5.5	16	203 542	
	32	70	NPT 1 1/4	5.5	16	203 544	
	40	90	NPT 1 1/2	5.5	16	203 545	
	50	90	NPT 2	5.5	16	203 546	

## RC threaded port

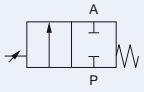
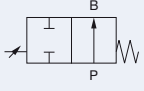
Control function	Orifice [mm]	Actuator size Ø [mm]	Port connection thread	Min. pilot pressure [bar]	Operating pressure up to +180°C [bar]	Item no. plug sealing PTFE/St. st.	Item no. plug sealing St. st./St. st.
<b>A</b> 2/2-way valve, NC 	13	50	RC 1/2	5.5	16	203 547	206 240
	20	70	RC 3/4	5.5	16	203 550	206 243
	25	70	RC 1/2	5.5	16	203 552	206 245
	32	70	RC 1 1/4	5.5	8.5	203 553	206 246
	40	90	RC 1 1/2	5.5	16	203 554	206 248
	50	90	RC 2	5.5	10	203 555	206 249
<b>B</b> 2/2-way valve, NO 	13	50	RC 1/2	5.5	16	203 556	
	20	50	RC 3/4	5.5	16	203 558	
	25	50	RC 1/2	5.5	16	203 560	
	32	70	RC 1 1/4	5.5	16	203 562	
	40	90	RC 1 1/2	5.5	16	203 563	
	50	90	RC 2	5.5	16	203 564	

Ordering chart Type 2300, flow direction below the seat (for gases and liquids), *continued*

Weld end acc. to EN ISO 112

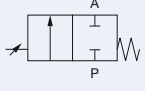
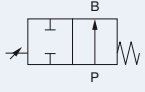
Control function	Orifice [mm]	Actuator size Ø [mm]	Port connection tube-Ø [mm]	Min. pilot pressure [bar]	Operating pressure up to +180°C [bar]	Item no. plug sealing PTFE/St. st.	Item no. plug sealing St. st./St. st.
<b>A</b> 2/2-way valve, NC 	15	50	21.3 x 1.6	5.5	16	203 565	206 250
	20	70	26.9 x 1.6	5.5	16	203 568	206 254
	25	70	33.7 x 2	5.5	16	203 570	206 256
	32	70	42.4 x 2	5.5	8.5	203 571	206 257
	40	90	48.3 x 2	5.5	16	203 572	206 258
	50	90	60.3 x 2.6	5.5	10	203 573	206 259
<b>B</b> 2/2-way valve, NO 	15	50	21.3 x 1.6	5.5	16	203 574	
	20	50	26.9 x 1.6	5.5	16	203 576	
	25	50	33.7 x 2	5.5	16	203 578	
	32	70	42.4 x 2	5.5	16	203 580	
	40	90	48.3 x 2	5.5	16	203 581	
	50	90	60.3 x 2.6	5.5	16	203 582	

Weld end acc. to DIN 11850 S2

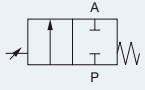
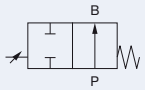
Control function	Orifice [mm]	Actuator size Ø [mm]	Port connection tube-Ø [mm]	Min. pilot pressure [bar]	Operating pressure up to +180°C [bar]	Item no. plug sealing PTFE/St. st.
<b>A</b> 2/2-way valve, NC 	15	50	19 x 1.5	5.5	16	203 583
	20	70	23 x 1.5	5.5	16	203 586
	25	70	29 x 1.5	5.5	16	203 588
	32	70	35 x 1.5	5.5	8.5	203 589
	40	90	41 x 1.5	5.5	16	203 590
	50	90	53 x 1.5	5.5	10	203 591
<b>B</b> 2/2-way valve, NO 	15	50	19 x 1.5	5.5	16	203 592
	20	50	23 x 1.5	5.5	16	203 594
	25	50	29 x 1.5	5.5	16	203 596
	32	70	35 x 1.5	5.5	16	203 598
	40	90	41 x 1.5	5.5	16	203 599
	50	90	53 x 1.5	5.5	16	203 600

Ordering chart Type 2300, flow direction below the seat (for gases and liquids), *continued*

## Weld end acc. to ASME BPE

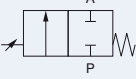
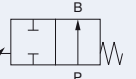
Control function	Orifice [mm]	Actuator size Ø [mm]	Port connection tube-Ø [mm]	Min. pilot pressure [bar]	Operating pressure up to +180°C [bar]	Item no. plug sealing PTFE/St. st.
<b>A</b> 2/2-way valve, NC 	15	50	12.7 x 1.65	5.5	16	203 601
	20	70	19.05 x 1.65	5.5	16	203 604
	25	70	25.4 x 1.65	5.5	16	203 606
	40	90	38.1 x 1.65	5.5	16	203 607
	50	90	50.8 x 1.65	5.5	10	203 608
<b>B</b> 2/2-way valve, NO 	15	50	12.7 x 1.65	5.5	16	203 609
	20	50	19.05 x 1.65	5.5	16	203 611
	25	50	25.4 x 1.65	5.5	16	203 613
	40	90	38.1 x 1.65	5.5	16	203 615
	50	90	50.8 x 1.65	5.5	16	203 616

## Weld end acc. to SMS 3008

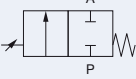
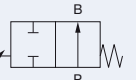
Control function	Orifice [mm]	Actuator size Ø [mm]	Port connection tube-Ø [mm]	Min. pilot pressure [bar]	Operating pressure up to +180°C [bar]	Item no. plug sealing PTFE/St. st.
<b>A</b> 2/2-way valve, NC 	15	50	12 x 1.0	5.5	16	203 617
	20	70	18 x 1.0	5.5	16	203 620
	25	70	25 x 1.2	5.5	16	203 622
	40	90	38 x 1.2	5.5	16	203 623
	50	90	51 x 1.2	5.5	10	203 624
<b>B</b> 2/2-way valve, NO 	15	50	12 x 1.0	5.5	16	203 625
	20	50	18 x 1.0	5.5	16	203 627
	25	50	25 x 1.2	5.5	16	203 629
	40	90	38 x 1.2	5.5	16	203 631
	50	90	51 x 1.2	5.5	16	203 632

## Weld end acc. to BS 4825

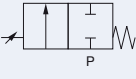
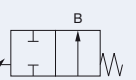
Control function	Orifice [mm]	Actuator size Ø [mm]	Port connection tube-Ø [mm]	Min. pilot pressure [bar]	Operating pressure up to +180°C [bar]	Item no. plug sealing PTFE/St. st.
<b>A</b> 2/2-way valve, NC 	15	50	12.7 x 1.2	5.5	16	203 633
	20	70	19.05 x 1.65	5.5	16	203 636
	25	70	25.4 x 1.65	5.5	16	203 638
	40	90	38.1 x 1.65	5.5	16	203 639
	50	90	50.8 x 1.65	5.5	10	203 640
<b>B</b> 2/2-way valve, NO 	15	50	12.7 x 1.2	5.5	16	203 641
	20	50	19.05 x 1.65	5.5	16	203 643
	25	50	25.4 x 1.65	5.5	16	203 645
	40	90	38.1 x 1.65	5.5	16	203 647
	50	90	50.8 x 1.65	5.5	16	203 648

Ordering chart Type 2300, flow direction below the seat (for gases and liquids), *continued*

## Clamp acc. to ISO 2852

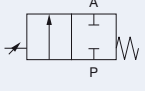
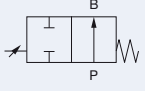
Control function	Orifice [mm]	Actuator size $\varnothing$ [mm]	Port connection clamp external $\varnothing$ [mm]	Min. pilot pressure [bar]	Operating pressure up to +180°C [bar]	Item no. plug sealing PTFE/St. st.
<b>A</b> 2/2-way valve, NC 	15	50	34.0	5.5	16	203 649
	20	70	50.5	5.5	16	203 652
	25	70	50.5	5.5	16	203 654
	32	70	50.5	5.5	8.5	203 655
	40	90	64.0	5.5	16	203 656
	50	90	77.5	5.5	10	203 657
<b>B</b> 2/2-way valve, NO 	15	50	34.0	5.5	16	203 658
	20	50	50.5	5.5	16	203 660
	25	50	50.5	5.5	16	203 662
	32	70	50.5	5.5	16	203 664
	40	90	64.0	5.5	16	203 665
	50	90	77.5	5.5	16	203 666

## Clamp acc. to ASME BPE

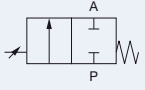
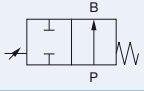
Control function	Orifice [mm]	Actuator size $\varnothing$ [mm]	Port connection clamp external $\varnothing$ [mm]	Min. pilot pressure [bar]	Operating pressure up to +180°C [bar]	Item no. plug sealing PTFE/St. st.
<b>A</b> 2/2-way valve, NC 	15	50	25.0	5.5	16	203 667
	20	70	25.0	5.5	16	203 670
	25	70	50.5	5.5	16	203 672
	40	90	50.5	5.5	16	203 673
	50	90	64.0	5.5	10	203 674
<b>B</b> 2/2-way valve, NO 	15	50	25.0	5.5	16	203 675
	20	50	25.0	5.5	16	203 678
	25	50	50.5	5.5	16	203 680
	40	90	50.5	5.5	16	203 682
	50	90	64.0	5.5	16	203 683

## Materials Type 2300

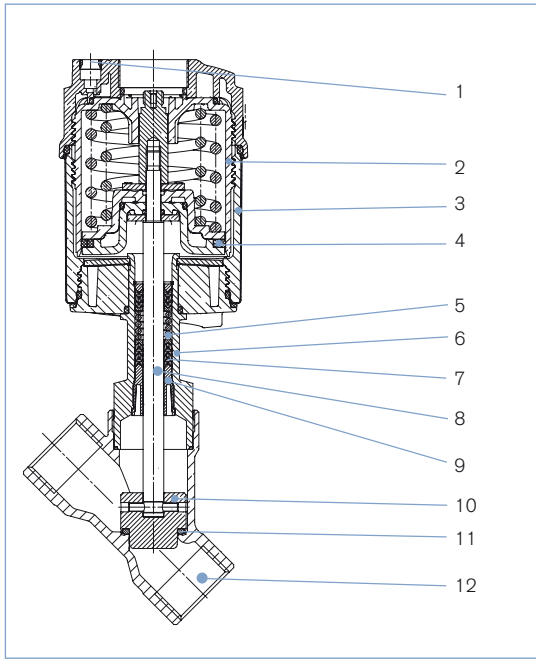

<b>1</b>	<b>Pilot air ports</b>	Push-in connector PP (standard)
<b>2</b>	<b>Actuator</b>	PPS
<b>3</b>	<b>Cover</b>	Stainless steel 1.4561 (316Ti)
<b>4</b>	<b>Piston seal</b>	FKM
<b>5</b>	<b>Spring</b>	Stainless steel 1.4310
<b>6</b>	<b>Pipe</b>	Stainless steel 1.4401 (316) (1.4404 (316L) on request)
<b>7</b>	<b>V-seals</b>	PTFE
<b>8</b>	<b>Spindle</b>	Stainless steel 1.4401 (316) (1.4404 (316L) on request)
<b>9</b>	<b>Wiper</b>	PEEK
<b>10</b>	<b>Plug</b>	Stainless steel 1.4571
<b>11</b>	<b>Plug seal</b>	Stainless steel 1.4571 (+PTFE disc for soft seat sealing)
<b>12</b>	<b>Valve body</b>	Stainless steel 316L

**Ordering information for valve system Continuous ELEMENT Type 8802-YG**

A valve system Continuous ELEMENT Type 8802-YG consists of an angle-seat control valve Type 2300 and a digital electropneumatic Positioner Type 8692, a digital electropneumatic Process Controller Type 8693 or a digital electropneumatic Positioner Basic Type 8694 (for valve actuator sizes  $\varnothing$  70/90 mm) or a digital electropneumatic Positioner Type 8696 (for valve actuator size  $\varnothing$  50 mm) (see separate datasheets).

For the configuration of further valve systems please use the "Request for quotation" on p. 16 [go to page](#)

You order two components and receive a complete assembled and certified valve.

**Ordering the valve system Continuous ELEMENT Type 8802-YG with valve actuator sizes  $\varnothing$  70/90 mm**

**Angle seat valve Type 2300 with actuator sizes  $\varnothing$  70/  $\varnothing$  90 mm**

**Control unit**



**Angle seat valve with desired control unit**



**Valve system Continuous ELEMENT Type 8802-YG-I 2300 + 8692**



**Valve system Continuous ELEMENT Type 8802-YG-J 2300 + 8693**



**Valve system Continuous ELEMENT Type 8802-YG-L 2300 + 8694**

Click on the orange box "More info." below... you will come to our website for the resp. product where you can download the datasheet.

**Positioner TopControl Type 8692**

**More info.**

**Process Controller TopControl Type 8693**

**More info.**



DeviceNet™



The new generation of integrated positioners/process controllers for combination with actuators from the process valve series Type 23xx/2103 is specially designed for the requirements of hygienic process environments. The easy handling and the selection of additional software functions are done either on a big graphic display with backlight and keypad or via a PC interface. A contact-free analog position sensor registers the valve position without deterioration. Single-acting or double-acting actuators are controlled via the integral positioner system. With Type 8693, the process controller function is superimposed on the position control loop. Profibus DPV1 and DeviceNet communication interfaces are available as options.

Main customer benefits:

- Compact design of the valve system with integrated positioner/process controller meets the demands for plant washdown environments through the selection of materials, external seals and integrated control air supply to the actuator
- Extremely simple commissioning and operation thanks to the backlighting of the graphics display and proven multilingual software structure
- Automatic parameterisation of the positioner and process controller using the TUNE functions
- Field bus communication via Profibus DPV1 or DeviceNet
- Air intake filter enhances the process valve system availability
- Simple and reliable actuator adaption
- Explosion-proof models for zone 2/22

**Positioner TopControl Basic Type 8694**

**More info.**



The new generation of integrated positioners for combination with actuators from the process valve series Type 23xx/2103 is specially designed for the requirements of hygienic process environments. The operation and selection of the software functions close tight function, inversion of the operating direction of the setpoint signal, characteristic curves selection and switching manual/automatic operation are effected via push-buttons and DIP switches or via the PC interface. The position setpoint is set using the standard signal 4 - 20 mA. In addition, the enable can be controlled via the binary input and an optional position feedback can be integrated. The positioner, Type 8694, registers the valve position without deterioration through a contact-free analogue position sensor. Single-acting or double-acting actuators are controlled via the integral positioner system. An AS-Interface communication interface is available as an option.

Main customer benefits:

- Compact design of the valve system with integrated positioner meets the demands for plant washdown environments through the selection of materials, external seals and integrated control air supply to the actuator
- Automatic parameterisation of the process controller using the Process TUNE function
- Field bus communication via optional AS-Interface
- Air intake filter enhances the process valve system availability
- Simple and reliable actuator adaption allowing additional actuators of the process valve series, Type 20xx or actuators from other manufacturers to be used
- Explosion-proof models for zone 2/22



**Ordering information for valve system Continuous ELEMENT Type 8802-YG, *continued***

A valve system Continuous ELEMENT Type 8802-YG consists of an angle-seat control valve Type 2300 and a digital electropneumatic Positioner Type 8692, a digital electropneumatic Process Controller Type 8693 or a digital electropneumatic Positioner Basic Type 8694 (for valve actuator sizes  $\varnothing$  70/90 mm) or a digital electropneumatic Positioner Type 8696 (for valve actuator size  $\varnothing$  50 mm) (see separate datasheets).

For the configuration of further valve systems please use the "Request for quotation" on p. 16 [go to page](#)

You order two components and receive a complete assembled and certified valve.

**Ordering the valve system Continuous ELEMENT Type 8802-YG with valve actuator size  $\varnothing$  50 mm**

**Angle seat valve Type 2300 with actuator sizes  $\varnothing$  50 mm**



**Control unit**



Type 8696

**Angle seat valve with desired control unit**



**Valve system**  
**Continuous ELEMENT**  
**Type 8802-YG-N**  
**2300 + 8696**

Click on the orange box "More info." below... you will come to our website for the resp. product where you can download the datasheet.

**TopControl Basic Type 8696**



**More info.**

The new generation of integrated positioners for combination with small actuators from the process valve series Type 23xx/2103 is specially designed for the requirements of hygienic process environments. The operation and selection of the software functions close tight function, inversion of the operating direction of the setpoint signal, characteristic curves selection and switching manual/automatic operation are effected via push-buttons and DIP switches or via the PC interface. The position setpoint is set using the standard signal 4 - 20 mA. In addition, the enable can be controlled via the binary input and an optional position feedback can be integrated. The positioner, Type 8696, registers the valve end position without deterioration through a contact-free analogue position sensor. Single-acting actuators are controlled via the integral positioner system.

Main customer benefits:

- Compact design of the valve system with integrated positioner meets the demands for plant washdown environments through the selection of materials, external seals and integrated control air supply to the actuator
- Automatic parameterisation of the positioner using the TUNE function
- Simple and reliable actuator adaption
- Explosion-proof models for zone 2/22

Dimensions for valve system Continuous ELEMENT Type 8802-YG [mm]

Dimensions valve system Continuous ELEMENT Type 8802-YG-I with positioner TopControl Type 8692 or 8802-YG-J with process controller TopControl Type 8693 [mm]

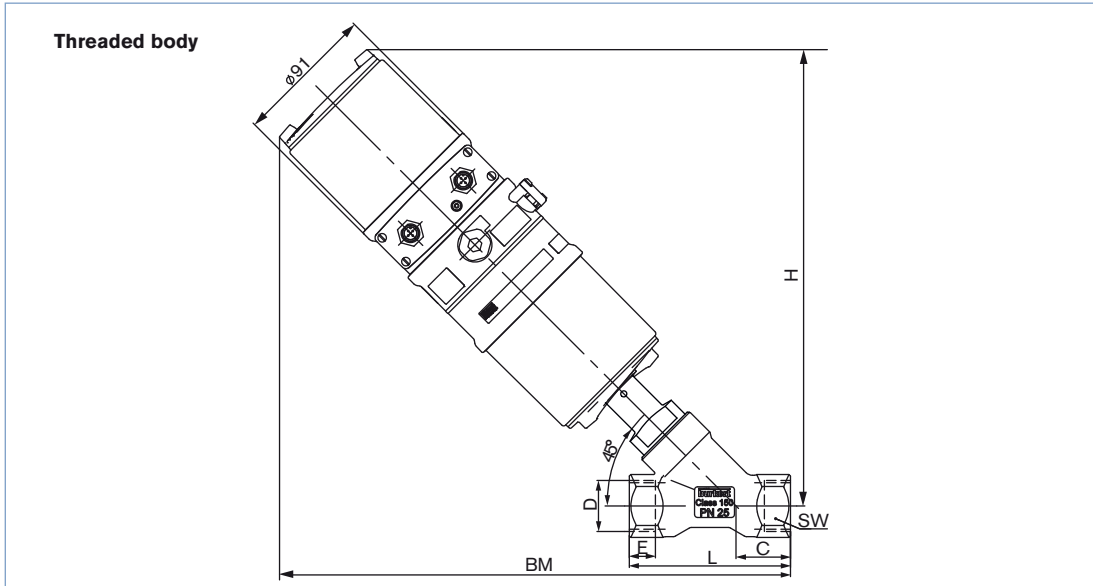

All bodies							G		NPT		Rc	
Orifice [mm]	Actuator size [mm]	H	BM	C	L	SW	D	E	D	E	D	E
20	70	287	322	35	95	32	G 3/4	16	NPT 3/4	14	RC 3/4	14.5
25	70	295	330	35.5	105	41	G 1	18	NPT 1	16.8	RC 1	16.8
32	70	301	343	41	120	50	G 1 1/4	20	NPT 1 1/4	17.3	RC 1 1/4	19.1
40	90	348	386	40	130	55	G 1 1/2	22	NPT 1 1/2	17.3	RC 1 1/2	19.1
50	90	362	405	45	150	65	G 2	24	NPT 2	17.6	RC 2	23.4

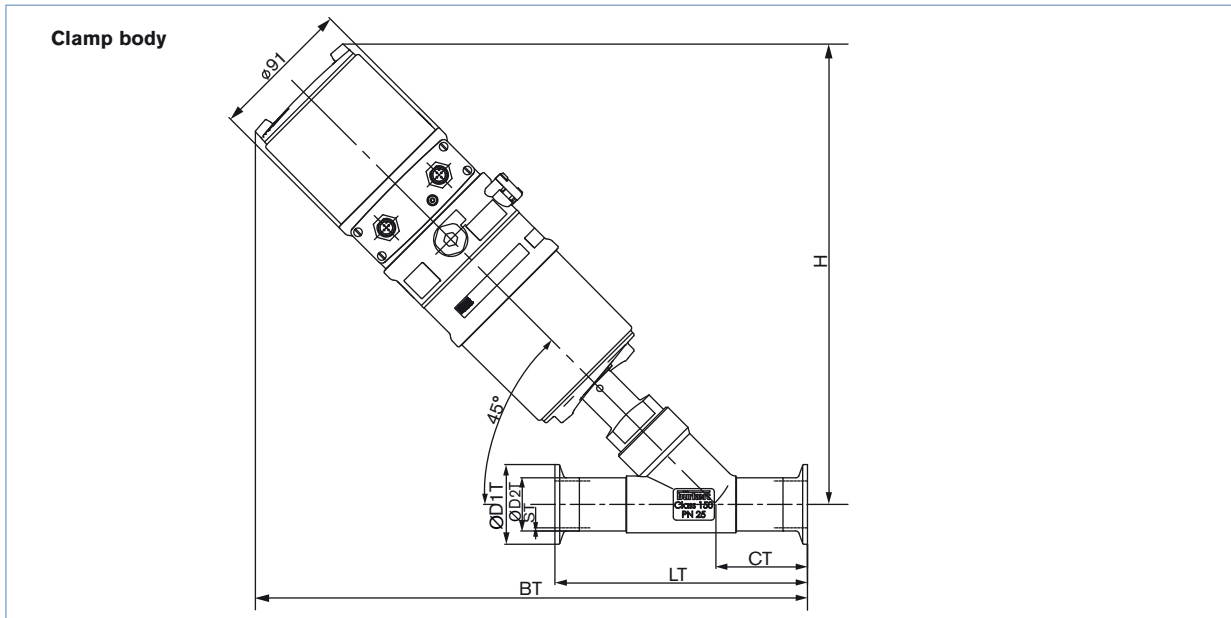

All clamp bodies							ISO 2852			DIN 32676			BS 4825			ASME BPE		
Orifice [mm]	Actuator size [mm]	H	BT	CT	LT	ST	ST	ST	ST	ST	ST	ST	ST	ST	ST	ST	ST	
20	70	287	344	57	150	50.5	26.9	1.6	34	23	1.5	25.2	19.05	1.2	25	19.05	1.65	
25	70	295	355	58.5	160	50.5	33.7	2	50.5	29	1.5	50.5	25.4	1.65	50.5	25.4	1.65	
32	70	301	360	58	180	50.5	42.4	2	50.5	35	1.5	-	-	-	-	-	-	
40	90	348	416	69.5	200	64	48.3	2	50.5	41	1.5	50.5	38.1	1.65	50.5	38.1	1.65	
50	90	362	438	78	230	77.5	60.3	2.6	64	53	1.5	64	50.8	1.65	64	50.8	1.65	

Dimensions for valve system Continuous ELEMENT Type 8802-YG [mm], continued

Dimensions valve system Continuous ELEMENT Type 8802-YG-I with positioner TopControl Type 8692 or 8802-YG-J with process controller TopControl Type 8693 [mm]

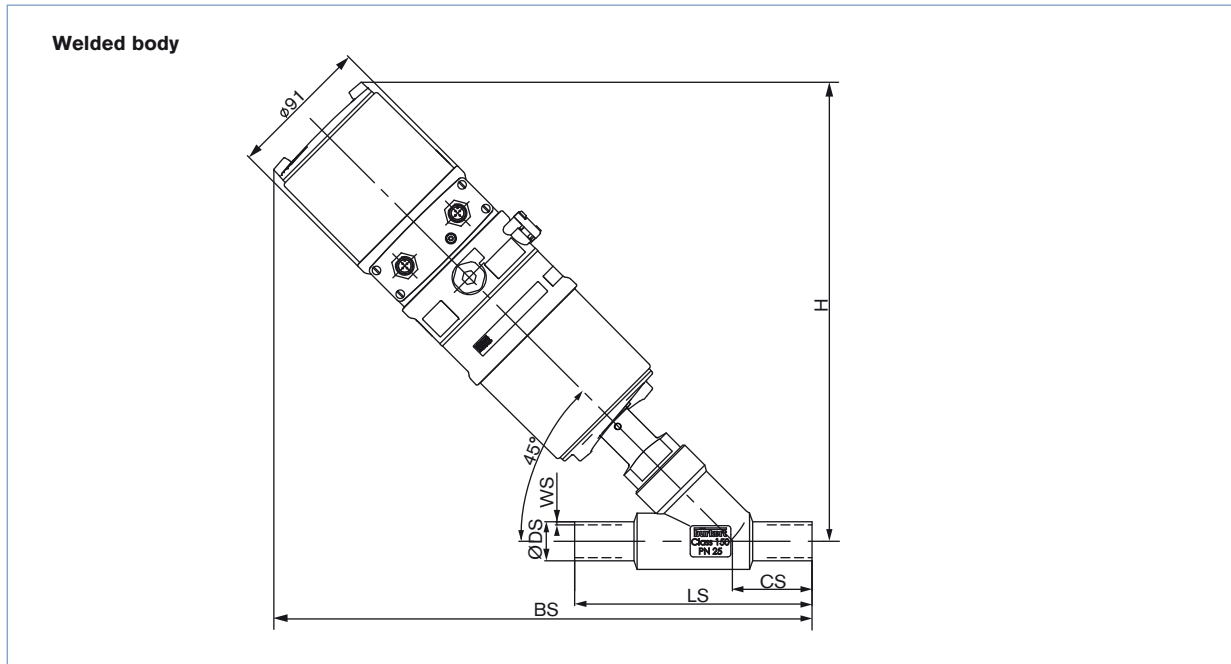

ISO 4200, DIN 11850 S2, ASME BPE

All bodies acc. to ISO 4200, DIN 11850 S2, ASME BPE, BS 4825						ISO 4200		DIN 11850 S2		ASME BPE		BS 4825	
Orifice [mm]	Actuator size [mm]	H	CS	LS	BS	WS	ø DS	WS	ø DS	WS	ø DS	WS	ø DS
20	70	287	39	115	326	1.6	26.9	1.5	23.0	1.65	19.05	1.2	19.05
25	70	295	43	130	339	2	33.7	1.5	29.0	1.65	25.4	1.65	25.4
32	70	301	40	145	342	2	42.4	1.5	35.0	-	-	-	-
40	90	348	49	160	395	2	48.3	1.5	41.0	1.65	38.1	1.65	38.1
50	90	362	50	175	410	2.6	60.3	1.5	53.0	1.65	50.8	1.65	50.8

SMS 3008

Orifice [mm]	Actuator size [mm]	H	CS	LS	BS	CS	LS	WS	ø DS
20	70	287	39	115	339	52	145	1.2	25.0
25	70	295	43	130	347	51	152	1.2	25.0
32	70	301	40	145	342	40	145	1.2	38.0
40	90	348	49	160	406	60	182	1.2	38.0
50	90	362	50	175	424	64	210	1.2	51.0

Dimensions for valve system Continuous ELEMENT Type 8802-YG [mm], continued

Dimensions valve system Continuous ELEMENT Type 8802-YG-L with positioner TopControl Basic Type 8694 [mm]

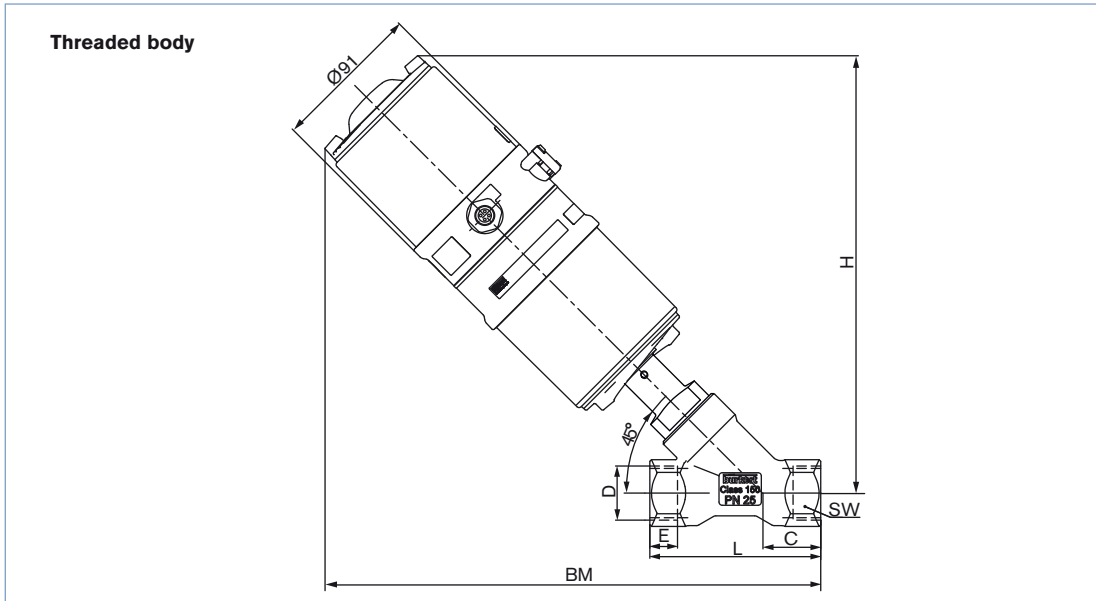

All threaded bodies		H	BM	C	L	SW	G		NPT		Rc	
Orifice [mm]	Actuator size [mm]						D	E	D	E	D	E
20	70	259	293	35	95	32	G 3/4	16	NPT 3/4	14	RC 3/4	14.5
25	70	267	302	35.5	105	41	G 1	18	NPT 1	16.8	RC 1	16.8
32	70	273	314	41	120	50	G 1 1/4	20	NPT 1 1/4	17.3	RC 1 1/4	19.1
40	90	318	357	40	130	55	G 1 1/2	22	NPT 1 1/2	17.3	RC 1 1/2	19.1
50	90	332	376	45	150	65	G 2	24	NPT 2	17.6	RC 2	23.4

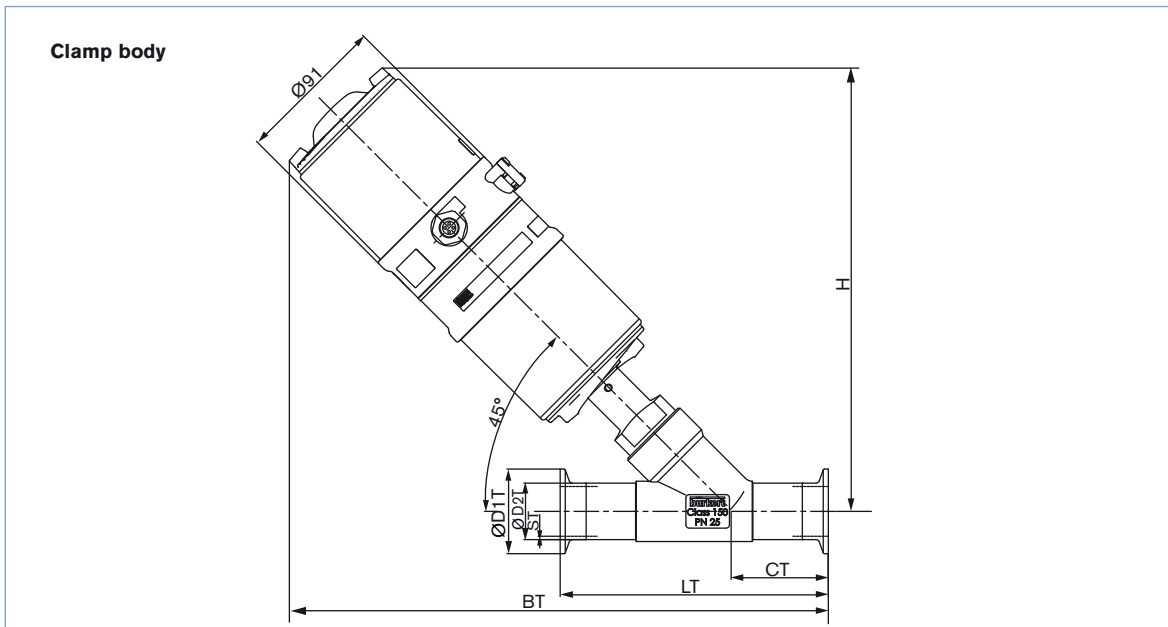

All clamp bodies		ISO 2852			DIN 32676			BS 4825			ASME BPE			
Orifice [mm]	Actuator size [mm]	H	BT	CT	LT	ø D1T	ø D2T	ST	ø D1T	ø D2T	ST	ø D1T	ø D2T	ST
20	70	259	315	57	150	50.5	26.9	1.6	34	23	1.5	25.2	19.05	1.2
25	70	267	325	58.5	160	50.5	33.7	2	50.5	29	1.5	50.5	25.4	1.65
32	70	273	331	58	180	50.5	42.4	2	50.5	35	1.5	-	-	-
40	90	318	386.5	69.5	200	64	48.3	2	50.5	41	1.5	50.5	38.1	1.65
50	90	332	409	78	230	77.5	60.3	2.6	64	53	1.5	64	50.8	1.65

**Dimensions for valve system Continuous ELEMENT Type 8802-YG [mm], continued**

**Dimensions valve system Continuous ELEMENT Type 8802-YG-L with positioner TopControl Basic Type 8694 [mm]**

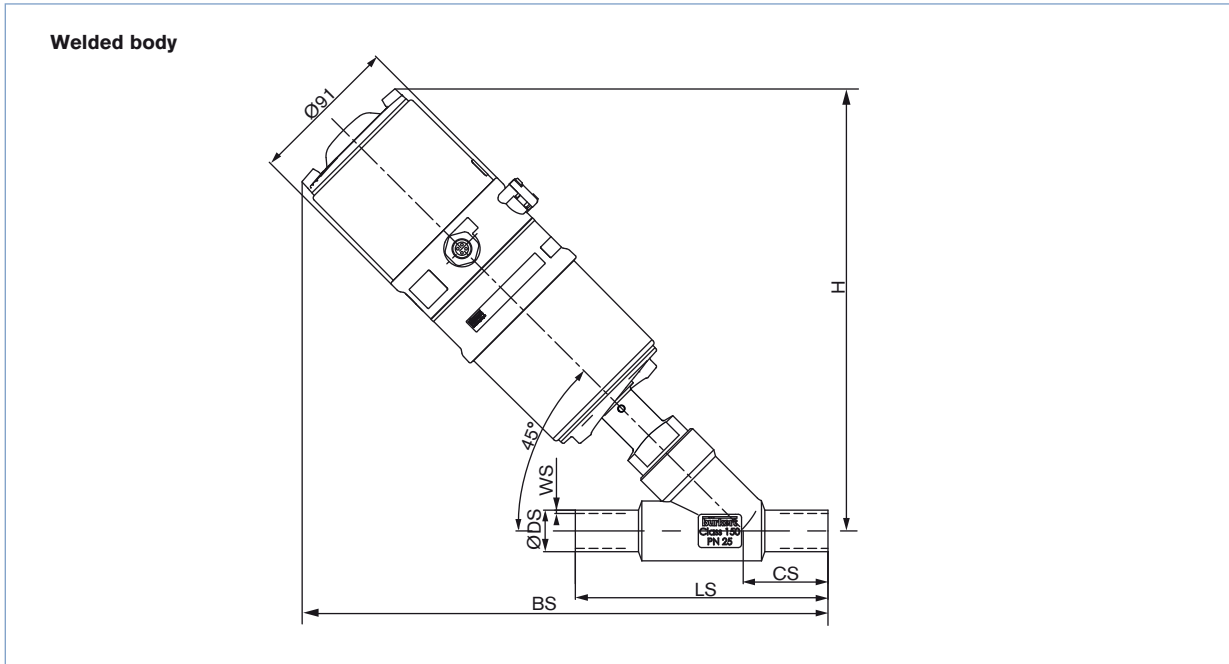

**ISO 4200, DIN 11850 S2, ASME BPE**

All welded bodies acc. to ISO 4200, DIN 11850 S2, ASME BPE, BS 4825						ISO 4200		DIN 11850 S2		ASME BPE		BS 4825	
Orifice [mm]	Actuator size [mm]	H	CS	LS	BS	WS	ø DS	WS	ø DS	WS	ø DS	WS	ø DS
20	70	259	39	115	297	1.6	26.9	1.5	23.0	1.65	19.05	1.2	19.05
25	70	267	43	130	309.5	2	33.7	1.5	29.0	1.65	25.4	1.65	25.4
32	70	273	40	145	313	2	42.4	1.5	35.0	-	-	-	-
40	90	318	49	160	366	2	48.3	1.5	41.0	1.65	38.1	1.65	38.1
50	90	332	50	175	381	2.6	60.3	1.5	53.0	1.65	50.8	1.65	50.8

**SMS 3008**

Orifice [mm]	Actuator size [mm]	H	BS	CS	LS	WS	ø DS
20	70	259	310	52	145	1.2	25.0
25	70	267	317.5	51	152	1.2	25.0
32	70	273	313	40	145	1.2	38.0
40	90	318	377	60	182	1.2	38.0
50	90	332	395	64	210	1.2	51.0

**Dimensions for valve system Continuous ELEMENT Type 8802-YG [mm], continued**

**Dimensions valve system Continuous ELEMENT Type 8802-YG with control head Type 8696 [mm]**

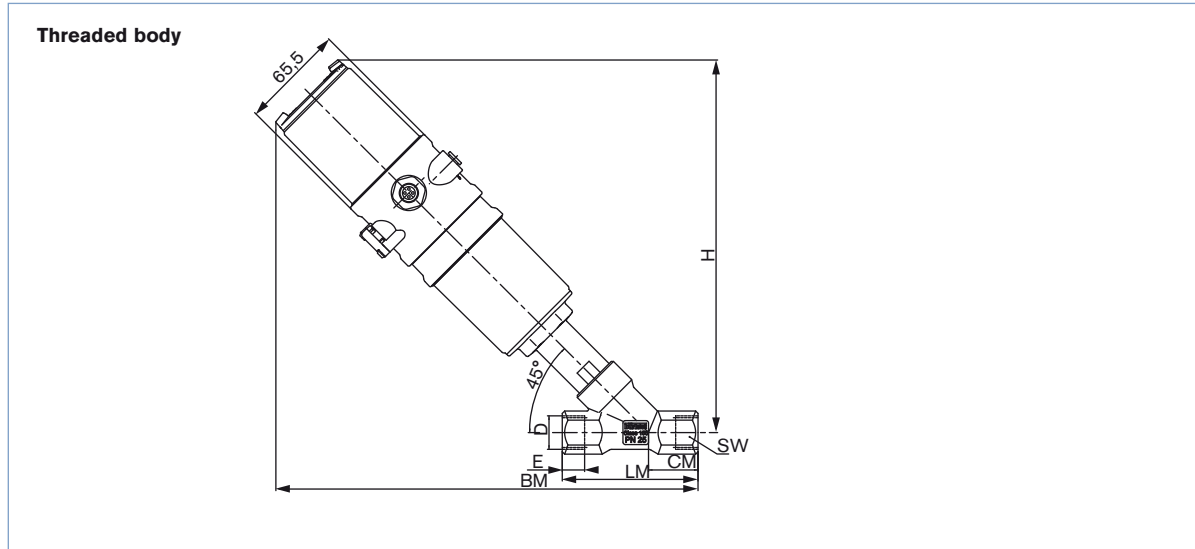

All threaded bodies							Port connection					
Orifice [mm]	Actuator size [mm]	H	BM	CM	SW	LM	G		NPT		RC	
							D	E	D	E	D	E
13	50	234	265	31	27	85	G 1/2	14	NPT 1/2	13.7	RC 1/2	13.2
			262	28	32		G 3/4	16	NPT 3/4	14	RC 3/4	14.5
20	50	242	276	35	32	95	G 3/4	16	NPT 3/4	14	RC 3/4	14.5
			272	31	41		G 1	18	NPT 1	16.8	RC 1	16.8
25	50	250	285	35.5	41	105	G 1	18	NPT 1	16.8	RC 1	16.8
			281	31.5	50		G 1 1/4	20	NPT 1 1/4	17.3	RC 1 1/4	19.1

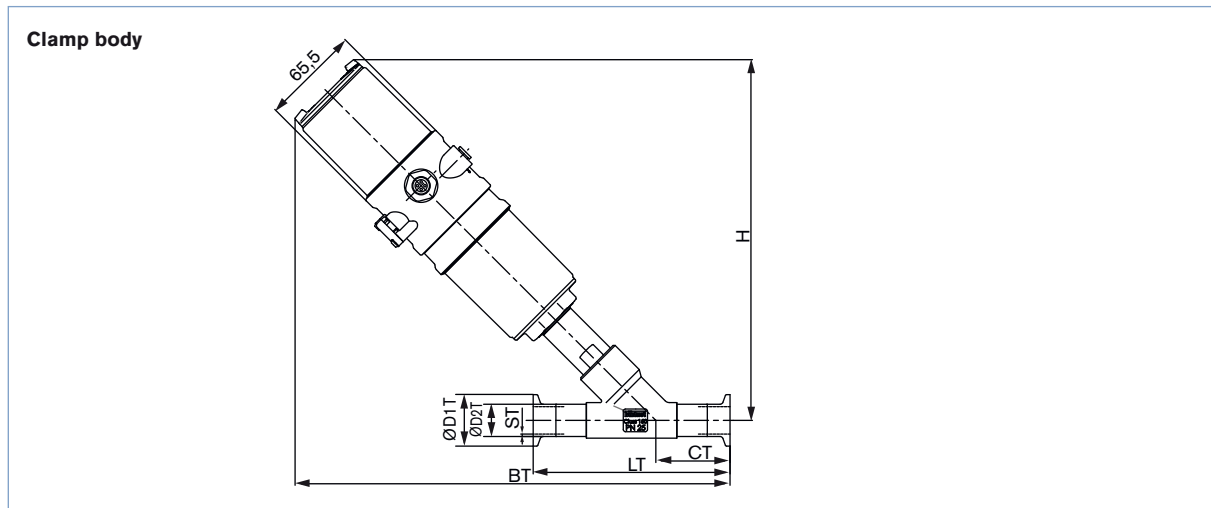

All clamp bodies					ISO 2852			DIN 32676			BS 4825			ASME BPE			
Orifice [mm]	Actuator size [mm]	H	BT	CT	LT	ØD1T	ØD2T	ST	ØD1T	ØD2T	ST	ØD1T	ØD2T	ST	ØD1T	ØD2T	ST
13	50	234	284	49.5	130	34	21.3	1.6	34	19	1.5	25.2	12.7	1.2	25	12.7	1.65
20	50	242	298	57	150	50.5	26.9	1.6	50.5	26.9	1.6	25.2	19.05	1.2	25	19.05	1.65
25	50	250	309	58.5	160	50.5	33.7	2	50.5	33.7	2	50.5	25.4	1.65	-	-	-

Dimensions for valve system Continuous ELEMENT Type 8802-YG [mm], continued

Dimensions valve system Continuous ELEMENT Type 8802-YG with control head Type 8696 [mm]

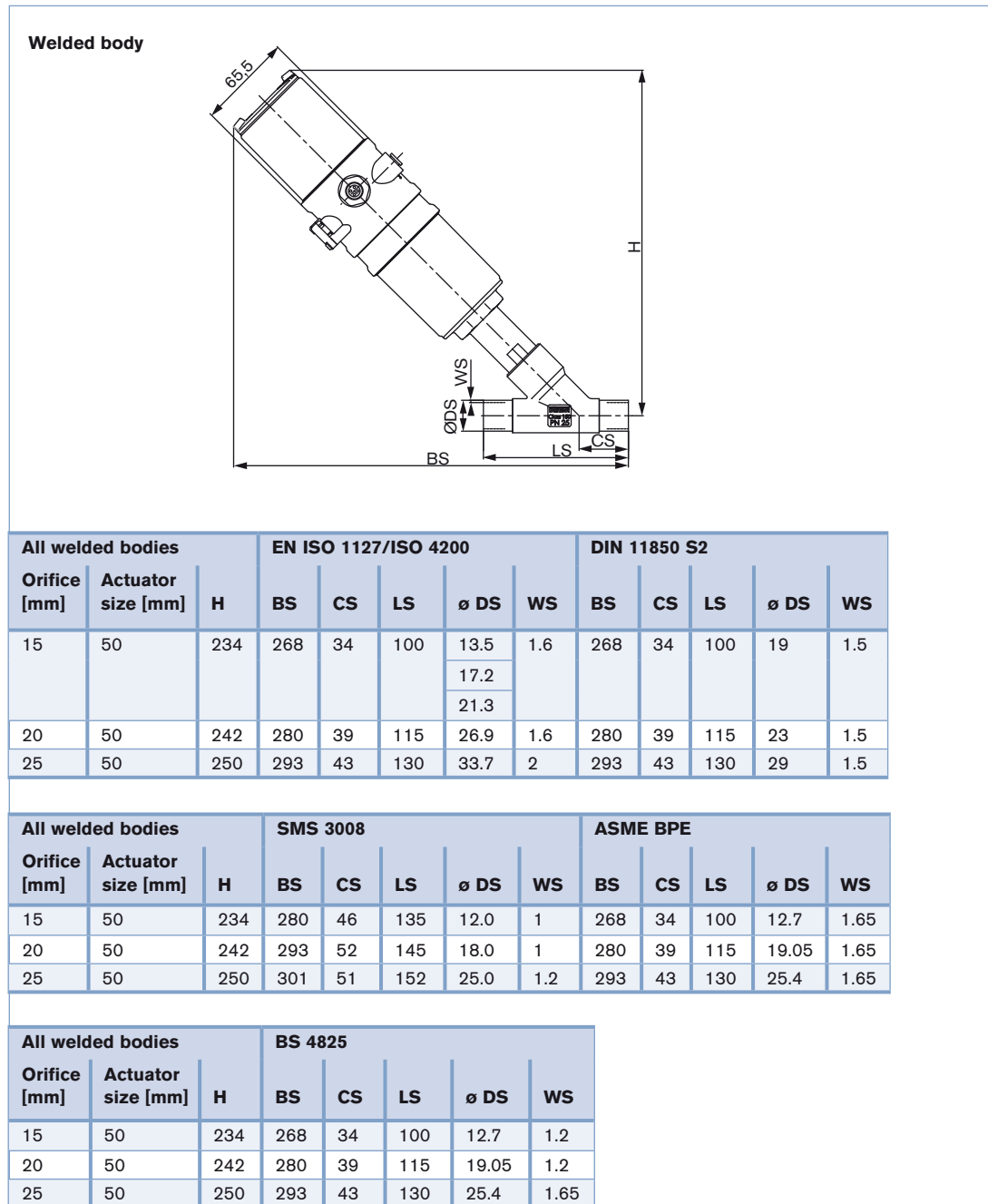

Valve system Continuous ELEMENT Type 8802-YG - Request for quotation

Note

You can fill out the fields directly in the PDF file before printing out the form.

Please fill out and send to your nearest Bürkert facility\* with your inquiry or order

Company	Contact person
Customer no.	Department
Address	Tel./Fax
Postcode/town	E-mail

= mandatory fields to fill out       Quantity       Required delivery date

Operating data

Pipe line	DN	<input type="text"/>	PN	<input type="text"/>
Pipe material	<input type="text"/>			
<input checked="" type="checkbox"/> Process medium	<input type="text"/>			
<input checked="" type="checkbox"/> Type of medium	<input type="checkbox"/> Liquid	<input type="checkbox"/> Steam	<input type="checkbox"/> Gas	
	min	standard	max	unit
<input checked="" type="checkbox"/> Flow rate (Q, Q <sub>N</sub> , W) <sup>1)</sup>	<input type="text"/>	<input type="text"/>	<input type="text"/>	<input type="text"/>
<input checked="" type="checkbox"/> Temperature at valve inlet T1	<input type="text"/>	<input type="text"/>	<input type="text"/>	<input type="text"/>
<input checked="" type="checkbox"/> Absolute pressure at valve inlet P1	<input type="text"/>	<input type="text"/>	<input type="text"/>	<input type="text"/>
<input checked="" type="checkbox"/> Absolute pressure at valve outlet P2	<input type="text"/>	<input type="text"/>	<input type="text"/>	<input type="text"/>
Steam pressure P <sub>v</sub>	<input type="text"/>	<input type="text"/>	<input type="text"/>	<input type="text"/>
Kinematic viscosity (ν)	<input type="text"/>	mm <sup>2</sup> /s or cSt		
Dynamic viscosity (η)	<input type="text"/>	mPa.s or cP		
Standard density	<input type="text"/>	Kg/m <sup>3</sup>		
Max. sound level accepted	<input type="text"/>	dB (A)		







<sup>1)</sup> standard unit: Liquid Q = m<sup>3</sup>/h; Steam W = kg/h; Gas Q<sub>N</sub> = Nm<sup>3</sup>/h

Valve features

Plug seal material	<input type="checkbox"/> PTFE/Stainless steel	<input type="checkbox"/> Stainless steel/Stainless steel	
Nominal pressure	PN	<input type="text"/>	
Orifice	DN	<input type="text"/>	
Type of connection	<input type="checkbox"/> Threaded	<input type="checkbox"/> Welded	<input type="checkbox"/> Clamp
Standard connection	<input type="checkbox"/> ISO	<input type="checkbox"/> DIN	<input type="checkbox"/> Other <input type="text"/>
Control function	<input type="checkbox"/> NC <sup>2)</sup>	<input type="checkbox"/> NO <sup>2)</sup>	
Please specify item no. if known:	<input type="text"/>		

<sup>2)</sup> NC: normally closed by spring action; NO: normally open by spring action

Control unit features

  For actuator sizes 70/90 mm		 For actuator size 50 mm
<input type="checkbox"/> Positioner TopControl Type 8692 	<input type="checkbox"/> Process Controller TopControl Type 8693 	<input type="checkbox"/> Positioner TopControl Basic Type 8694 
<b>Pneumatic function</b> <input type="checkbox"/> Single-acting <input type="checkbox"/> Double-acting	<b>Pneumatic function</b> <input type="checkbox"/> Single-acting	<b>Pneumatic function</b> <input type="checkbox"/> Single-acting
<b>Communication</b> <input type="checkbox"/> Profibus <input type="checkbox"/> DeviceNet	<b>Pilot air ports</b> <input type="checkbox"/> Push-in connector external ø 6 mm or 1/4" <input type="checkbox"/> Thread G 1/8"	<b>Pilot air ports</b> <input type="checkbox"/> Push-in connector external ø 6 mm or 1/4" <input type="checkbox"/> Thread G 1/8"
<b>Electrical connection</b> <input type="checkbox"/> Cable gland <input type="checkbox"/> Multipol connection	<b>Feedback</b> <input type="checkbox"/> 4-20 mA <input type="checkbox"/> 4-20 mA + 2 binary outputs	<b>Feedback</b> <input type="checkbox"/> 4-20 mA
<b>Initiator</b> <input type="checkbox"/> Initiator	Please specify item no. if known: <input type="text"/>	Please specify item no. if known: <input type="text"/>

Comments

\* To find your nearest Bürkert facility, click on the orange box → [www.burkert.com](http://www.burkert.com)

In case of special application conditions, please consult for advice.

Subject to alteration.  
© Christian Bürkert GmbH & Co. KG

0909/6\_EU-en\_00895101